

1

Four pictorial views of a tent are shown below. State the **drawing type** used in each of the views.

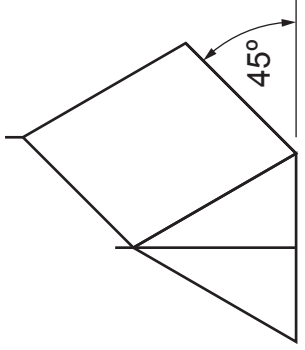

(a) .....

(1)

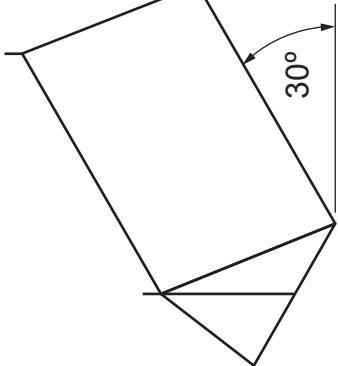

(b) .....

(1)

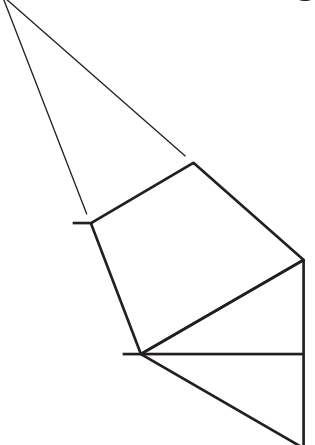

(c) .....

(1)

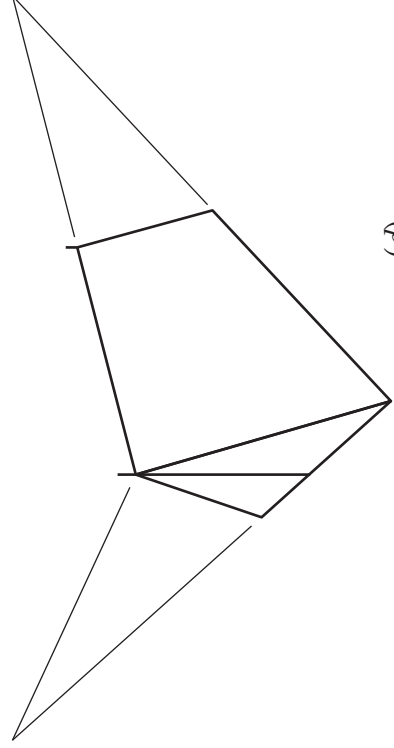

(d) .....

(1)

(4 marks)

2

The various stages in producing a CAD drawing of a caravan are shown below. Identify the **single** command used to produce each stage.

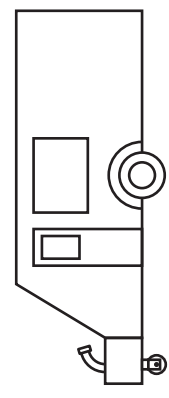
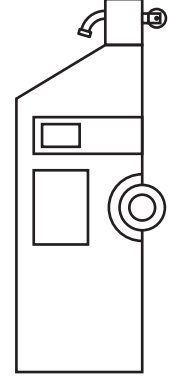

(a) .....

(1)

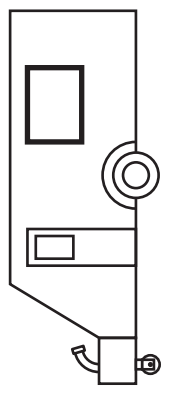
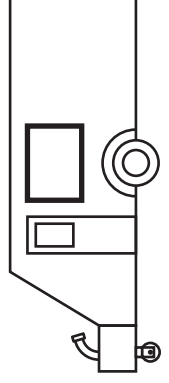

(b) .....

(1)

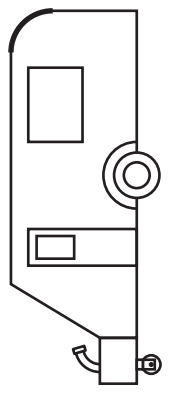
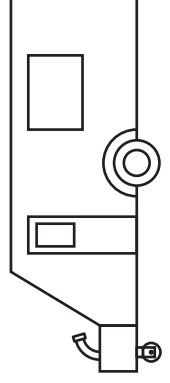

(c) .....

(1)

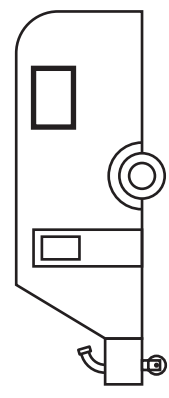
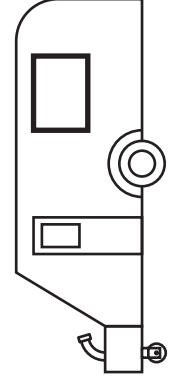

(d) .....

(1)

(4 marks)

A pictorial view and elevation of a new tent peg design are given below. Add the following dimensions to the elevation, according to British Standards.

- (a) Angle **W**     **45 degrees**     **(1)**
- (b) Length of edge **X**     **140 mm**     **(1)**
- (c) Length of edge **Y**     **85 mm**     **(1)**
- (d) Diameter **Z**     **17 mm**     **(1)**

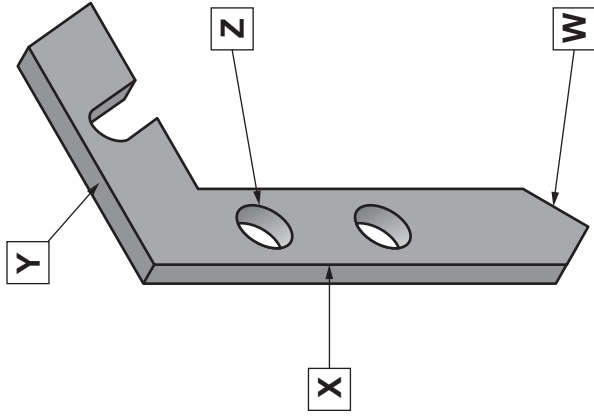

**Pictorial view not to scale**

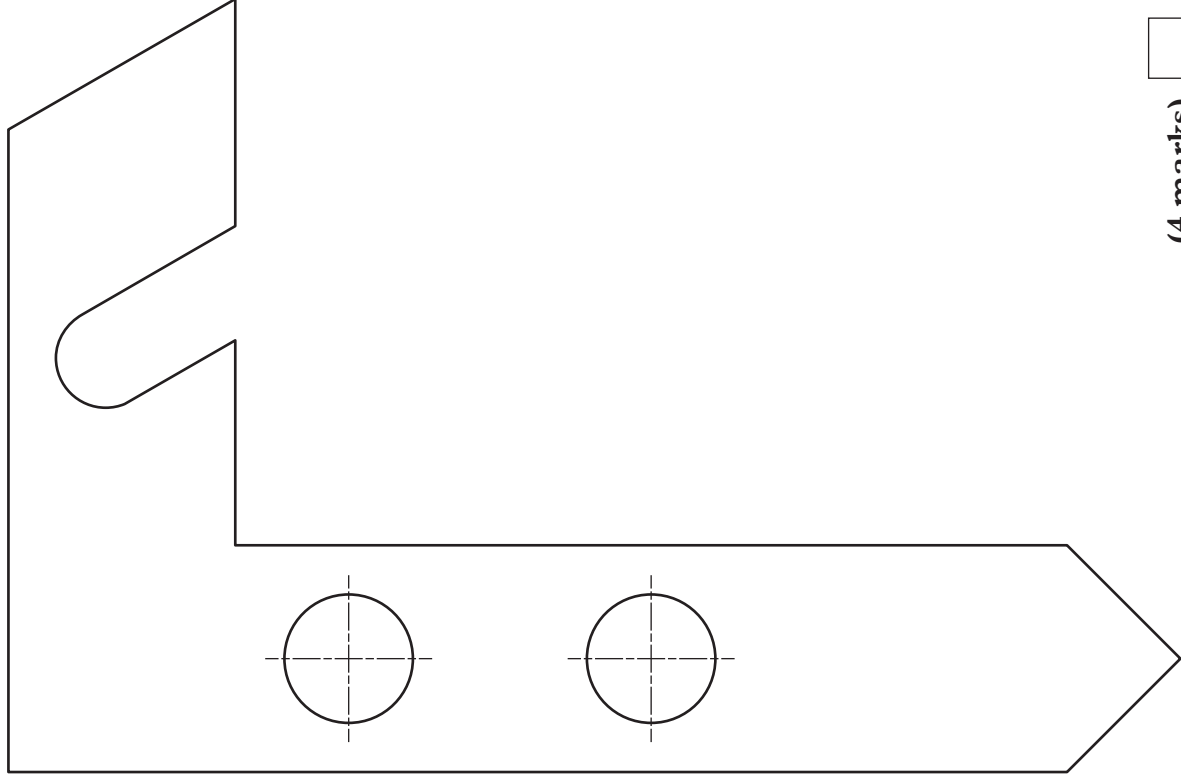

**(4 marks)**

**Elevation shown at scale 1 : 1**

A desktop published document is shown below. State the DTP features indicated.



# Campsite Rules

10. You may take vehicles (cars, vans etc) onto your site to load and unload providing it has not rained recently.

11. Always put wood, pallets and bricks back in the woodpile area.

12. Take all your rubbish home or burn it, but do not leave tin cans in the embers of any fire.

13. Never light a fire other than in a designated area and please do not dig up the turf from any camping site, we may withhold your deposit if you do.

14. Generators are not to be used on the campsite as they can spoil the quiet of the evening for other campers.

15. Respect quiet hours in the campsite, if you are a large group try and find a more isolated spot away from others. If you will be playing music, keep it at a reasonable level at night or turn it off if people close by are sleeping.

16. If a site area states "no pets" respect this.

17. All pitches must be vacated by 12 noon on the day of departure unless by prior arrangement with reception or the warden.

18. The entrance barrier will be locked between the hours of 11.00 pm and 7.00 am allowing pedestrian access only.

1. The speed limit on the park is 5mph.

2. Children must not be allowed to play in or around the facilities block or in the park entrance, and must be supervised at all times.

3. Always shut the gates at night and lock them when you are off site.

4. Always leave the padlocks in place locked shut and remember to lock the toilet block when you are off site.

5. Never turn on any of the heaters—they use a lot of electricity and are only intended to stop the pipes from freezing—if you turn them on you will be charged for the electricity used.

6. Always fill the hot water heaters with water before switching them on and never turn off the mains water.

7. Never put tents of any description in the Flag pole area, it should be kept free at all times.

8. Never park a vehicle anywhere except in the car park.

9. Trailers (etc) may be kept with you on your site provided they are not taking up valuable camping space and not a hazard to other camps, additional parking is available on the grass in front of the toilet block but never restrict access to any one else.

**Grand Trees Campsite**

**a**

**b**

**c**

- (a) ..... **(1)**
- (b) ..... **(1)**
- (c) ..... **(1)**
- (d) State the page orientation of the document shown above. .... **(1)**

**(4 marks)**

A holiday camp has designed a new staff uniform.

An illustration of this is shown opposite.

(a) Red was chosen for the jacket colour. State **one** reason for this.

.....  
 ..... (1)

(b) State a **tertiary** colour which contrasts with the red jacket, which could be used for the campsite logo.

..... (1)

(c) State a **harmonising** colour to the red jacket, that could be used for the shirt.

..... (1)

(d) A **shade** of red was chosen for the trouser colour.

State what is added to red to create a shade of red.

..... (1)

(4 marks)

